

6999

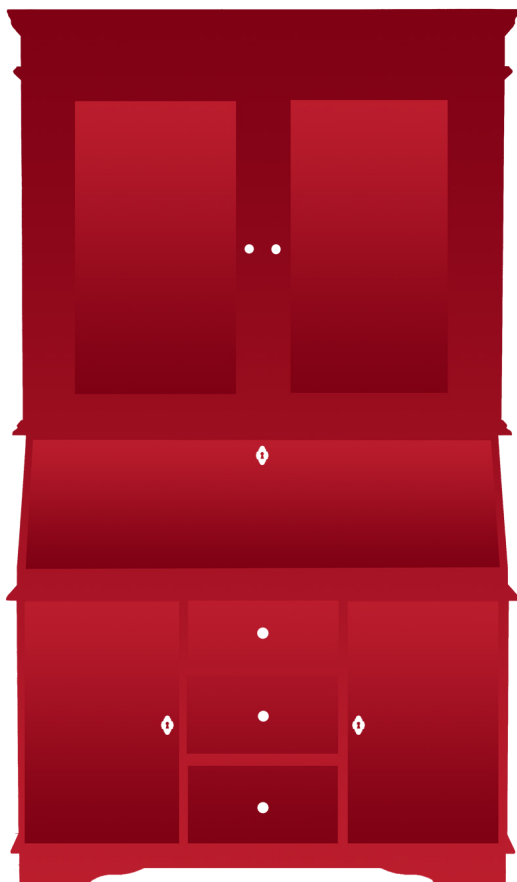

MADE IN ITALY



# Lorenza



# Welcome to Casapitti

*A genuine italian tale made of people, tradition and quality.*

Our mission is to bring into your home our Italian artistic heritage and expert craftsmanship. Your new piece of furniture has been manufactured in Verona, Italy, by skilled artisans using certified Carb2 strong woods and hand painted with water based colors by our artists in Florence, Italy. Because we love our planet as much as you do.

Each Casapitti furniture piece is destined to last for generations and become more beautiful over time. Our artisans craft every item by hand, some colors and variances may appear different from the photo you saw on our website, this is a statement of its uniqueness and singularity. It is the beauty of having a piece of Art, like nobody else has.

Enjoy!



Olivia Lentucci - Founder

## LIST OF CONTENTS

This section lists the contents included in the box to assemble your Lorenza cabinet. Please take time to identify the hardware as well as the individual components of the product. As you unpack and prepare for assembly, place the contents on a carpeted or padded area to protect them from damage. Please follow the assembly instructions closely. Improper assembly can result in personal or property damage.



(A) 24 screws



(B) 6 connector plates

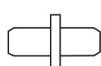

(C) 16 Shelf Supports

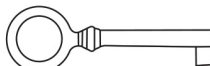

(D) 4 Keys (includes spare)

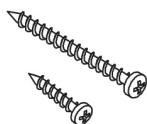
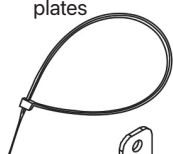

(E) 2 Wall Anchoring (Anti-tip) Kit

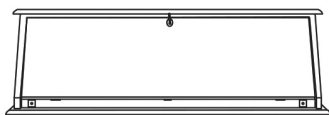

(F) 1 Desk

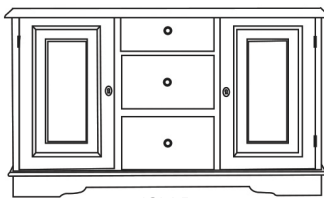

(G) 1 Base

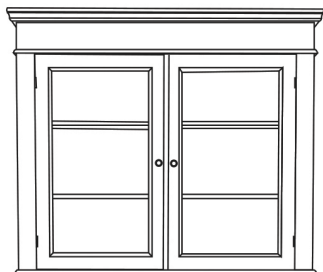

(H) 1 Hutch

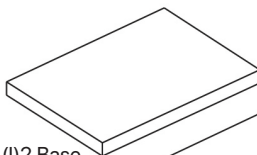

(I) 2 Base Shelves

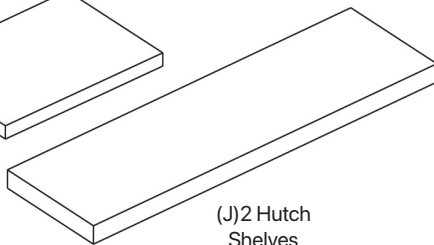

(J) 2 Hutch Shelves

- Carefully lift Desk (F) and place on top of Base (G). Center and align then join both together by placing Connector Brackets (B) as illustrated below and securing with Screws (A). **WARNING:** To prevent tip-over, Connector Brackets (B) must be used to join units.

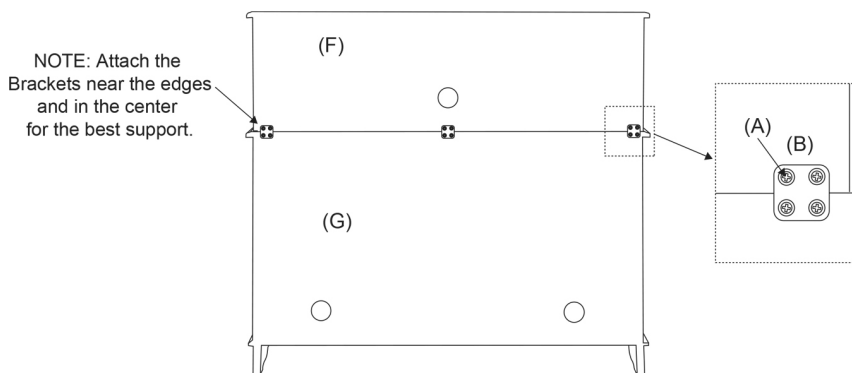

- Determine location for each Base Shelf (I) then insert Shelf Supports (C) into corresponding pre-drilled holes. Carefully set each Shelf level upon Supports.

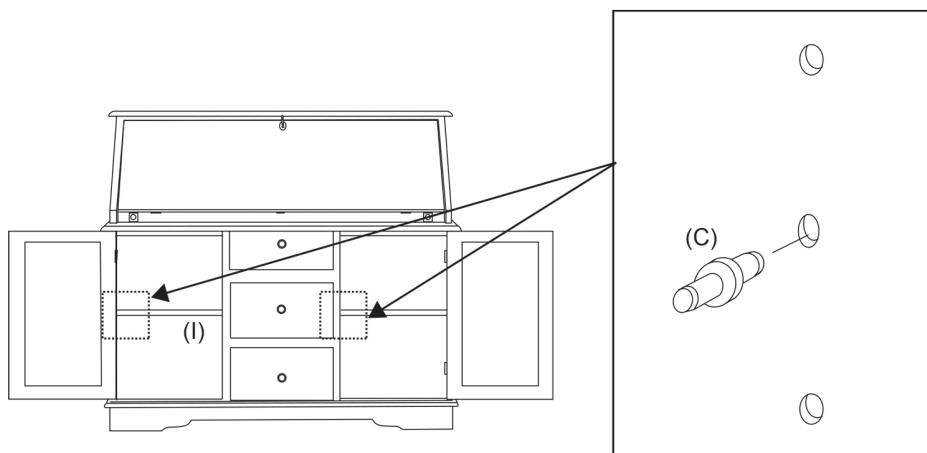

- Carefully lift Hutch (H) and place on top of Desk (F). Center and align then join both together by placing Connector Brackets (B) as illustrated below and securing with Screws (A).

**WARNING: To prevent tip-over, Connector Brackets (B) must be used to join**

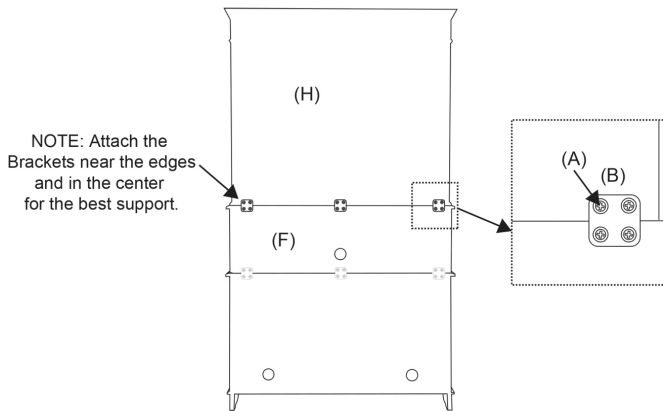

- Determine location for each Hutch Shelf (J) then insert Shelf Supports (C) into corresponding pre-drilled holes. Carefully set each Shelf level upon Supports.

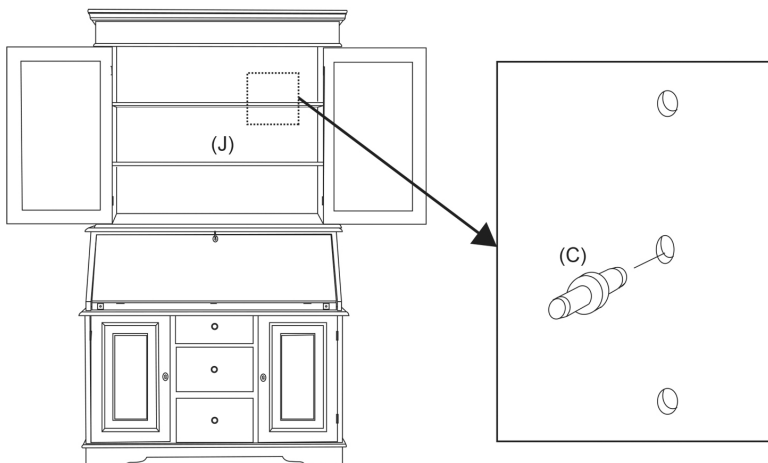



### WARNING Tip-Over Hazard

Serious or fatal crushing injuries can occur from a furniture tip-over. Prevent tipping accidents. Anchor your furniture.



A x 02  
Large screw



B x 02  
Small screw

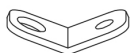

C x 04  
Bracket



D x 02  
Retention Belt

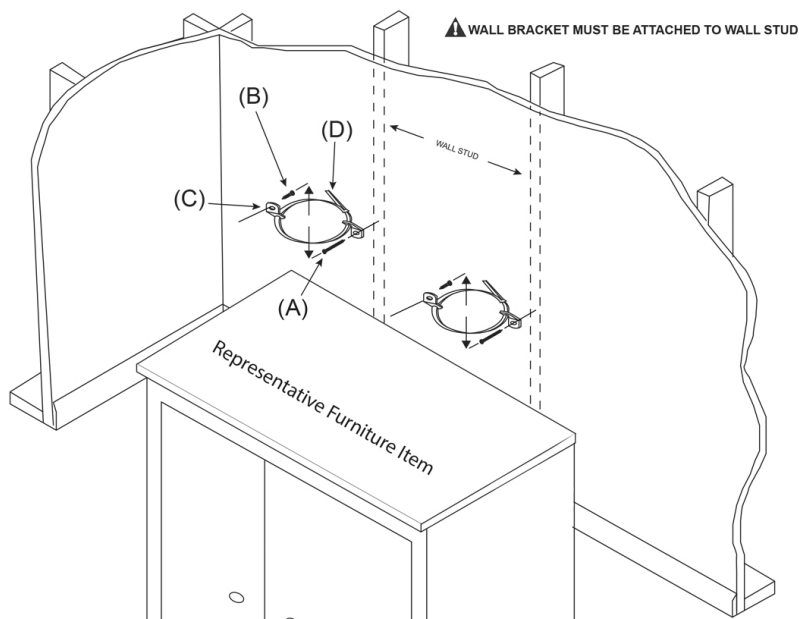

With a little care you can prolong the life of your furniture. Follow the instructions for the materials of your specific product to make sure that it stays in the best shape for as long as possible. The information below is only intended as a general guideline. For more information on how to remove specific stains, please enquire the Casapitti team. Always remove stains quickly before they can do any permanent damage to

### WOOD MAINTENANCE

Avoid accidental impacts with hard objects because the finish may get damaged. In case of accidental spills and/or stains on wooden tops, act quickly by blotting the surface with a clean dry cloth or with an absorbent paper and get rid of any excess liquid after each cleaning operation. Repeat the treatment if necessary. Do not use abrasive substances. Keep the product away from the heat. Make sure that the elements touching the floor are kept away from dampness. Avoid any contact with chemical substances commonly used for floor cleaning.



Clean surfaces with a dry or damp soft cloth.



Do not use abrasive cleaners.



Periodically check and tighten hardware as necessary.

GET IN TOUCH

---

## CUSTOMER SERVICE



Reach us on  
Whatsapp



B&D Home  
Via Virginio 584  
50025 Montespertoli  
Florence (Italy)

[info@casapitti.com](mailto:info@casapitti.com)



[@casapittihome](https://www.instagram.com/casapittihome)